



**FIELDMANN**<sup>®</sup>  
Home & Garden Performance



FZZ 4003 / 4006

---

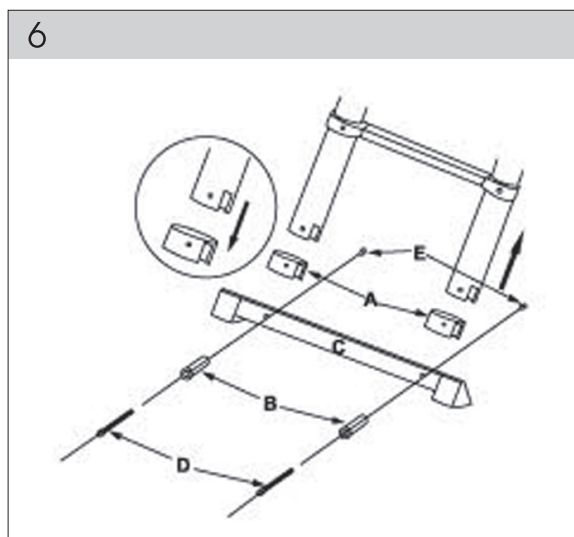
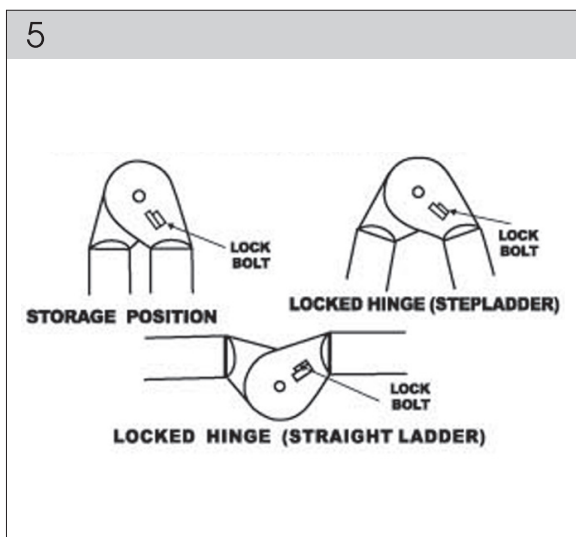
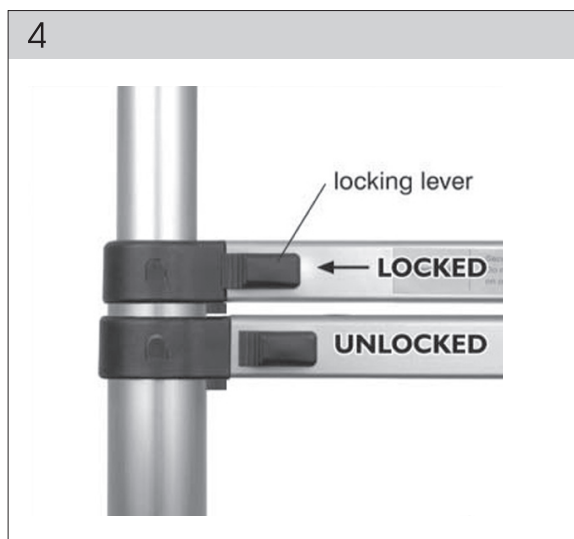
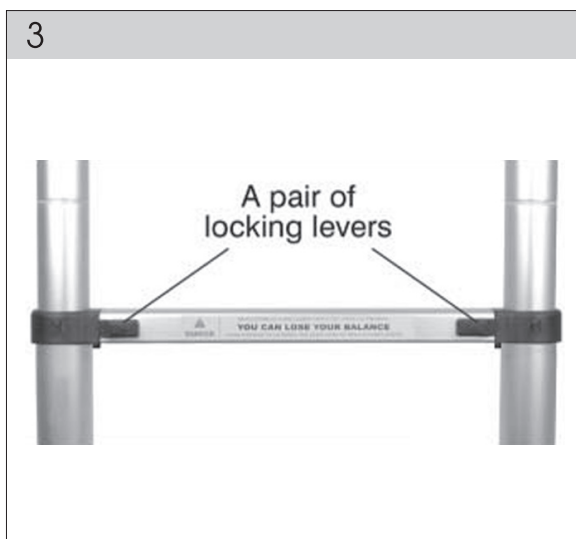
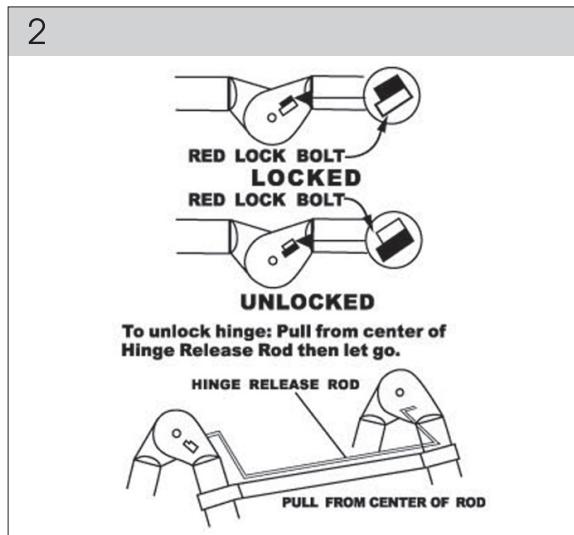
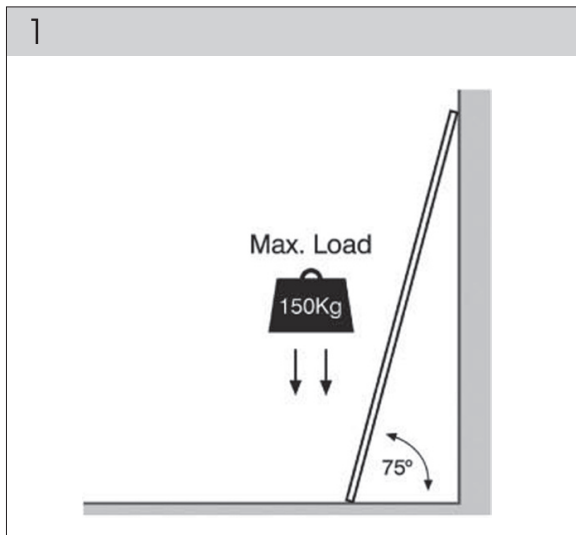

# Multipurpose Telescopic Ladder

## USER MANUAL

Instructions Manual - language version only.

**Thank you for having bought this multipurpose telescopic ladder. Before you start using it, please read carefully this user manual and retain it for further use.**

## CONTENTS

FIGURE ATTACHMENT .....	3
1. GENERAL SAFETY INSTRUCTIONS .....	6
Important safety warnings	
Packaging	
Operating instructions	
2. EXPLANATION OF INSTRUCTION LABELS .....	7
3. IMPORTANT SAFETY INSTRUCTIONS .....	8
4. PRODUCT DESCRIPTION AND ITEMS DELIVERED .....	9
5. LOCKING MECHANISMS .....	10
6. FUNCTION OF JOINTS .....	10
7. LOCKING OF JOINTS .....	10
8. POSITION OF JOINTS .....	10
9. GUIDELINES FOR SUPPORTING ROD ASSEMBLY .....	11
10. LADDER EXTENSION .....	11
11. LADDER FOLDING .....	11
12. STORAGE .....	11

# 1. GENERAL SAFETY INSTRUCTIONS

## Important safety warnings

- ✿ Unpack the product carefully and be sure not to throw away any part of the package before having found all components of the product.
- ✿ Keep the product in a dry place out of reach of children.
- ✿ Read all cautions and instructions. The failure to adhere to warning cautions and instructions may result in an accident, fire and/or a serious injury.

## Packaging

The product is placed in a package preventing damage during transport. This package is a raw material therefore it can be handed-over for recycling.

## Instructions for use























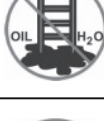

Before beginning to work with the product, read the following safety rules and instructions for use. Familiarize with operating elements and the proper use of the device. Keep the manual in a safe place for future reference. We recommend keeping the original package including the inner packaging materials, cash voucher and guarantee card for a period of warranty at minimum. For a case of transportation, pack the product into the original box from the manufacturer, thus ensuring a maximum protection of the product during a possible transport (e.g. moving or sending into a service station).

 **Note:** If you hand the product over to next persons, hand it over together with the manual. Adherence to the attached instructions for use is a precondition for the proper use of the product. The operation manual includes also instructions for operation, maintenance and repairs.

 **WARNING!** In order to prevent a serious injury or fatal accident, please read all these instructions before use and follow all the warnings on product labels! Retain this manual together with the product for future review.

**The manufacturer does not assume any responsibility for the accidents or damage incurred due to the failure to follow this manual.**

## 2. EXPLANATION OF INSTRUCTION LABELS

		1. Read the instruction manual attentively prior to use Fig. 1
		2. Maximum load of ladder/stepladder is 150 kg Fig. 2
		3. Both models (ladder/stepladder) are intended for one user only Fig. 3
		4. Adjust the ladder so that the angle between the ladder and the wall is 75° and the ladder base is placed in ca. 1/4 of the ladder working length Fig. 4
		5. Make sure the stepladder is fully extended prior to use Fig. 5
		6. Lock the upper and bottom ends of the ladder Fig. 6
		7. Check the ladder/stepladder footings always prior to use Fig. 7
		8. Check the ladder/stepladder visually always prior to use Fig. 8
		9. Ladder overlap above the landing point Fig. 9
		10. Never step off the ladder/stepladder Fig. 10
		11. Both models (ladder/stepladder) are intended for one person on the ascending arm only Fig. 11
		12. Never lean out of the ladder/stepladder Fig. 12
		13. Make sure the ground is properly cleaned Fig. 13
		14. Make sure the ladder/stepladder is placed on the solid surface Fig. 14
		15. Make sure the ladder/stepladder is placed on the even surface Fig. 15
		16. Use the ladder/stepladder in an appropriate way only Fig. 16
		17. Never use the ladder/stepladder as a bridge or gangway Fig. 17
		18. Never step on the top step of the ladder Fig. 18
		19. Make sure the upper end of the ladder is appropriately positioned Fig. 19
		20. Mind a risk of electric shock when carrying the ladder/stepladder Fig. 20
		21. Face the ladder when both ascending and descending Fig. 21,22

## 3. IMPORTANT SAFETY INFORMATION

**⚠ WARNING!** Metal conducts electricity! Avoid a contact of the ladder or any of the components with live power lines.

- ✿ Read the Instruction Manual attentively before use.
- ✿ Make sure you are fit enough to use the ladder. Certain medical conditions or medication alcohol or drugs abuse could make ladder use unsafe.
- ✿ Before using a ladder at work a risk assessment should be carried out respecting the legislation in the country of use.
- ✿ The maximum load of the ladder totals 150 kg. The mass of the user plus the mass of the material shall not exceed 150 kg.
- ✿ When transporting ladders on roof bars or in a truck, ensure they are suitably placed to prevent damage.
- ✿ Locking devices, if fitted, shall be fully secured before use. All locking devices shall be completely secured when the ladder is fully extended.
- ✿ Visually check that the ladder is not damaged and is safe to use at the start of each working day when the ladder is to be used.
- ✿ For professional users regular periodic inspections are required.
- ✿ Use only the ladder with a regular distance between the individual rungs.
- ✿ Do not use any extensions, components or accessories unless sold or recommended by the ladder manufacturer.
- ✿ Inspect the ladder after delivery and before first use to confirm condition and operation of all parts. Check all parts of the ladder always prior each use. Do not use the ladder provided that any parts are missing, damaged or worn out. For professional users regular periodic inspections are required.
- ✿ Ensure the ladder is suitable for the task.
- ✿ Do not try to modify the ladder in any way. Unauthorized modifications may result in serious injury and consequent invalidation of the guarantee.
- ✿ Never try to repair the damaged ladder. Have the damaged ladder always repaired by a qualified technician.
- ✿ Do not use the damaged ladder.
- ✿ Remove any contamination from the ladder such as wet paint, mud, oil or snow.
- ✿ Dispose the ladder when exposed to excessive heat (such as a fire in a house) or to corrosive agents (acids or alkalis).

### Using the Ladder

- ✿ Do not exceed the maximum total load specified for the type of ladder.
- ✿ Do not lean out of the ladder; users should keep their belt buckle (navel) inside the stiles and both feet on the same step/rung throughout the task.
- ✿ Do not step off a leaning ladder at a higher level without additional security, such as tying off or use of a suitable stability device.

- ✿ Do not use stepladders for access to another level (next floor).
- ✿ Do not stand on the top three steps/rungs of a leaning ladder.
- ✿ Do not stand on the top two steps/rungs of a stepladder without a platform and hand/knee rail.
- ✿ Do not stand on the top four steps/rungs of a stepladder with an extending ladder (section) at the top.
- ✿ Ladders should only be used for light work of short duration.
- ✿ Use non-conductive ladders for unavoidable live electrical work.
- ✿ Do not use the ladder outdoor in adverse weather conditions, such as strong winds.
- ✿ Take precautions against children playing on the ladder.
- ✿ Secure doors (not fire doors or emergency exits) and windows where possible in the work area.
- ✿ Face the ladder when ascending and descending.
- ✿ Keep a secure grip on the ladder when ascending and descending.
- ✿ Do not use the ladder as a bridge.
- ✿ Wear suitable footwear when climbing a ladder.
- ✿ Avoid excessive lateral loadings, e.g. drilling brick and concrete.
- ✿ Do not spend long periods of time on a ladder without regular breaks (tiredness is a risk).
- ✿ Leaning ladders used for access to a higher level should be extended at least 1 m above the landing point.
- ✿ Equipment carried while using a ladder should be light and easy to handle.
- ✿ Avoid work that imposes a lateral load on stepladders, such as side drilling through solid materials (e.g. brick or concrete).
- ✿ Cling to the handrail whilst working from a ladder or take additional safety precautions if you cannot.

### **Repair, Maintenance and Storage**

- ✿ Repairs and maintenance shall be carried out by a qualified person and be in accordance with the instructions given by the manufacturer. Ladders shall be stored in compliance with the instructions given by the manufacturer.

## 4. PRODUCT DESCRIPTION AND SCOPE OF DELIVERY (Fig. 6)

- A - 2 x connecting elements
- B - 2 x sockets
- C - supporting rod
- D - 2 x bolts
- E - 2 x locking nuts



## 5. LOCKING MECHANISMS

**⚠ WARNING!** Before use first get familiar with ladder function!

- ✿ Each ladder rung has several locking mechanisms. They consist of steel pins with a spring that automatically lock in their place when the ladder gets extended.
- ✿ Each mechanism is connected with a locking lever visible on the outer side (see Fig. 3). Locking levers have two functions. They indicate whether the mechanism is locked or not, and serve as buttons for pin release (when shortening the ladder).
- ✿ When the lever is close to the side, it indicates that the mechanism is locked. When the lever is farther from the side, it indicates that the mechanism is not locked (see Fig.4).

**⚠ WARNING!** It can happen that locking mechanism audibly clicked shut but always check visually whether the levers are visibly locked. Locking mechanism must be fully locked before use.

**⚠ WARNING!** Locking mechanism must be fully locked before ladder use.

## 6. FUNCTION OF JOINTS (Fig. 2)

## 7. LOCKING OF JOINTS

- ✿ Unfold the ladder into an open position with locked joints. Make sure that locking bolts at both joints are locked in their position. Check the label at both joints to make sure they are locked. (To check locking it is necessary to swing ladder section lightly back and forth.)

## 8. POSITION OF JOINTS (Fig. 5)

- ✿ Before using the ladder make sure that all joints are locked.
- ✿ For releasing the joint release rod never use anything but your arm.
- ✿ For ladder adjustment, moving or transport never use anything but the joint release rod.
- ✿ Do not use the ladder unless locking bolts are locked in place.
- ✿ Maintain joints clean and free of any impurities, paint, snow, etc.
- ✿ Joints on this ladder were greased during the manufacturing process but in order to get best functionality depending on actual use, clean joints and lubricate them regularly with light machine oil.



## 9. GUIDELINES FOR SUPPORTING ROD ASSEMBLY

**⚠ WARNING!** Before use fix the supporting rod safely to the sides.

- ✿ Insert the supporting rod into round openings of connecting segments.
- ✿ Pass the sockets through the round openings of connecting segments through the supporting rod.
- ✿ Insert round connecting segments into ladder endings (make sure the mats face downwards).
- ✿ Pass the bolts into sockets through the sides.
- ✿ Put locking nuts on the bolts and tighten firmly.

## 10. LADDER EXTENSION

### Telescopic Stepladder

- ✿ Grasp the ladder with both arms from both sides and pull up so much that you pull this section as appropriate. Then pull the release rod to the frame position in the form of letter A and then lock the joint.

### Straight telescopic ladder

- ✿ Pull the release rod to the straight position lock the joint. Extend the ladder step by step as needed.

### Step telescopic ladder

- ✿ Grasp the ladder with both arms from both sides and pull up so much that you pull this section as appropriate. Then pull the release rod to the frame position in the form of letter A and then lock the joint. Bend one side into an appropriate position to create steps.

## 11. LADDER FOLDING

- ✿ After you finish working with the ladder, you can again fold the ladder in the storage size.
- ✿ Fold the ladder and then push it back step by step with both arms.

## 12. STORAGE

- ✿ The ladder must be stored at a safe dry place out of reach of children and excessive heat.

